

# ASSEMBLY INSTRUCTIONS

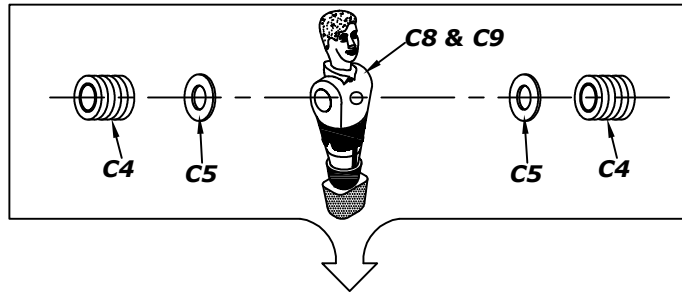







## SOCCER TABLE ASSEMBLY

WARNING: TWO ADULTS NEEDED TO ASSEMBLE SOCCER TABLE



# TABLE SOCCER



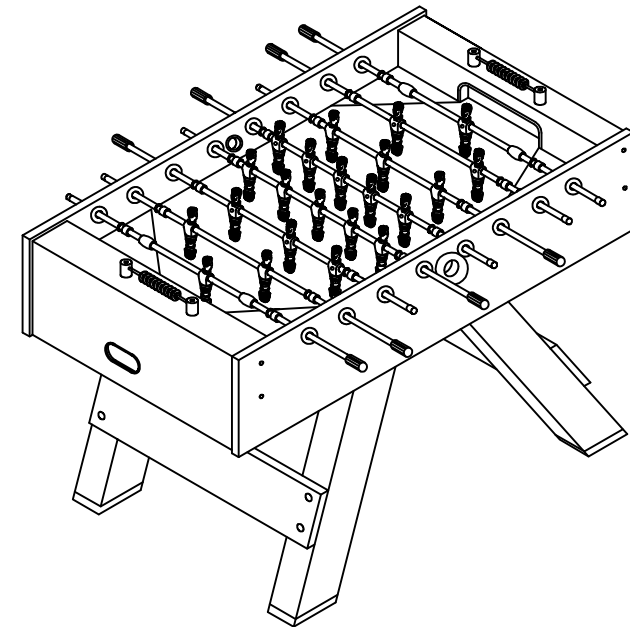

## ASSEMBLY INSTRUCTIONS

			<i>QTY</i>
	<b>R1</b>	5 HOME PLAYERS ROD	1
	<b>R2</b>	3 HOME PLAYERS ROD	2
	<b>R3</b>	2 HOME PLAYERS ROD	1
	<b>R4</b>	1 HOME PLAYERS ROD	1
	<b>R5</b>	5 AWAY PLAYERS ROD	2
	<b>R6</b>	3 AWAY PLAYERS ROD	2
	<b>R7</b>	2 AWAY PLAYERS ROD	2
	<b>R8</b>	1 AWAY PLAYERS ROD	1



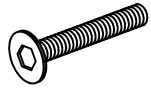
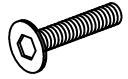

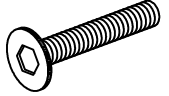
# PARTS IDENTIFIER

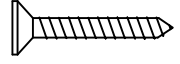
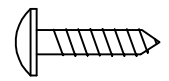
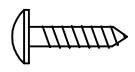
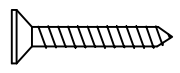
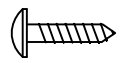
## HARDWARE

	DESCRIPTION	QTY. REQUIRED
	<b>H1</b> 1/4"x1-5/8" BOLT	8
	<b>H2</b> 1/4"x1-1/8" BOLT	8
	<b>H3</b> 1/4" WASHER, BLACK FLAT	16
	<b>H4</b> 5/16"x1-1/8" BOLT	12
	<b>H5</b> 5/16" WASHER, BLACK FLAT	12
	<b>H6</b> 1" FLAT HEAD PHILLIPS SCREW	8
	<b>H7</b> 5/8" ROUND HEAD PHILLIPS SCREW	2
	<b>H8</b> 1/2" ROUND HEAD PHILLIPS SCREW	24
	<b>H9</b> 1-3/4" FLAT HEAD PHILLIPS SCREW	4
	<b>H10</b> 3/8" ROUND HEAD PHILLIPS SCREW	4

## ACCESSORIES

	DESCRIPTION	QTY
	<b>A1</b> SOCCER BALL	4
	<b>A2</b> TOOL	1

# ASSEMBLY INSTRUCTIONS

## SOCCER TABLE ASSEMBLY

**WARNING: TWO ADULTS NEEDED TO ASSEMBLE SOCCER TABLE**

- INSERT THE PLAYER RODS **C1&C2&C3** THROUGH ONE SIDE PANEL, THEN INSERT PLAYERS **C8&C9** AND RUBBER BUSHINGS **C4**, PLASTIC WASHERS **C5** THROUGH THE ROD, REFER TO **R1~R8**. THEN INSERT THE PLAYER ROD THROUGH OTHER SIDE PANEL, ATTACH THE PLAYERS **C8&C9** WITH BOLTS **C6** AND NUTS **C7**. SEE **Figure 5**.
- ATTACH BALL ENTRY CUPS **P9A** AND BALL ENTRY SOCKET **P9B** TO THE SIDE PANELS WITH SCREWS **H7** AS SHOWN IN **figure 5**. ATTACH THE TWO SETS OF SLIDE SCORER **P10** TO THE END OF TABLE WITH PHILLIS HEAD SCREWS **H9**.
- SLIDE THE HANDLES **P7** ONTO THE ENDS OF THE RODS WITH THE HOLE CLOSE TO THE END. SLIDE THE RUBBER CAPS **P8** ON THE OTHER END OF THE ROD.

**Tighten all the hardware before playing games !**

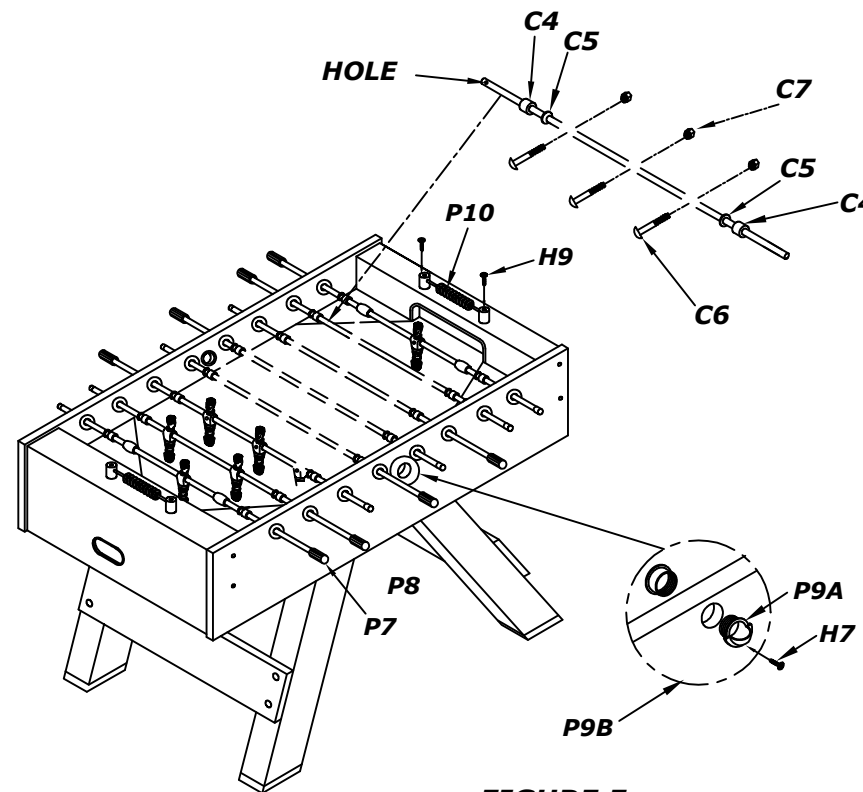

**FIGURE 5**

# ASSEMBLY INSTRUCTIONS

## SOCCKER TABLE ASSEMBLY

**WARNING: TWO ADULTS NEEDED TO ASSEMBLE SOCCER TABLE**

4. ATTACH THE LEGS **P4&P4B** AS SHOWN IN **figure 3**.  
 THE LEGS ARE ATTACHED WITH BOLTS **H4** AND WASHERS **H5**.  
 ATTACH THE LEG PANELS **P4C** WITH BOLTS **H2** AND WASHERS **H3**.  
 (TIGHTEN HARDWARE AT THIS TIME).

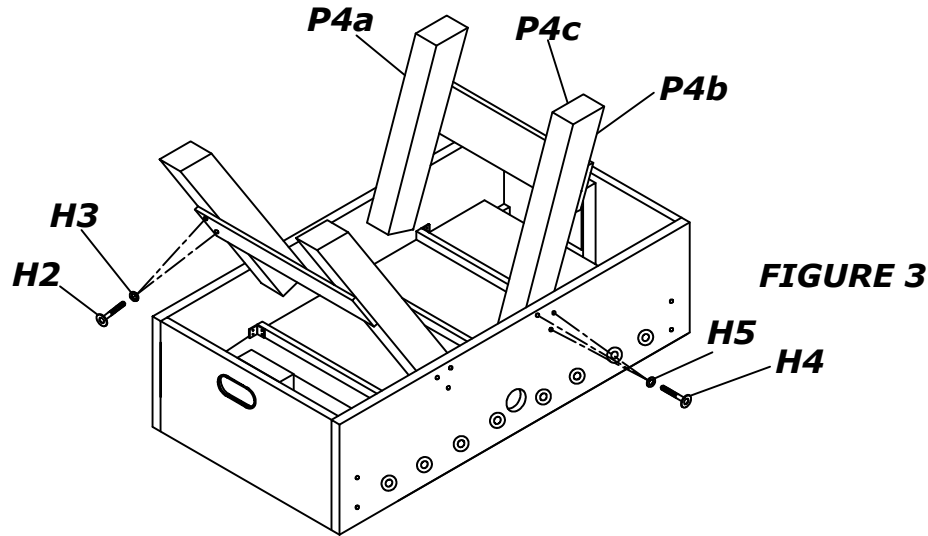



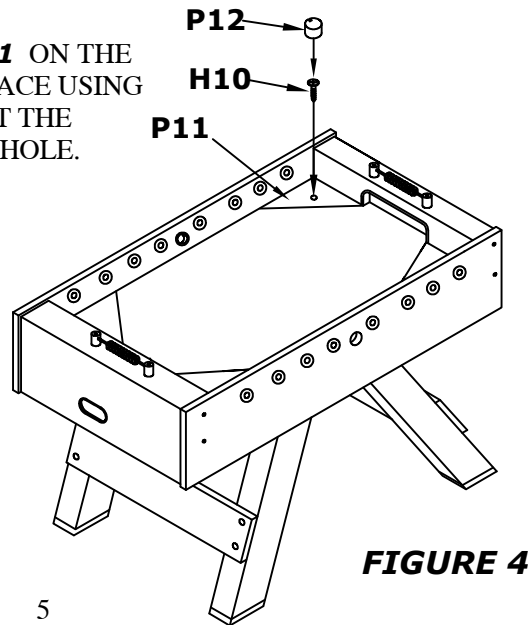





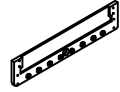

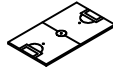



5. PLACE THE TRIANGLES **P11** ON THE CORNER OF PLAYING SURFACE USING SCREWS **H10**, THEN INSERT THE PLUGS **P12** TO COVER THE HOLE. SEE **FIGURE 4**.









# PARTS IDENTIFIER

## ASSEMBLY PARTS

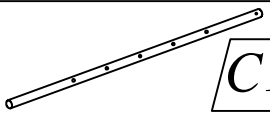
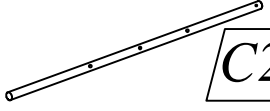
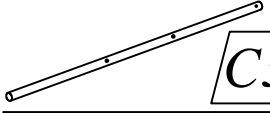
	DESCRIPTION	QTY
	<b>P1</b> SIDE PANEL	2
	<b>P2</b> END PANEL	2
	<b>P3</b> PLAYING FIELD	1
	<b>P4A</b> LEG A	2
	<b>P4B</b> LEG B	2
	<b>P4C</b> LEG PANEL	2
	<b>P5</b> PLAYFIELD SUPPORT BRACE	3
	<b>P6</b> SUPPORT BRACKET	6
	<b>P7</b> HANDLE	8
	<b>P8</b> ROD END CAP	8
	<b>P9A</b> BALL ENTRY CUP	2
	<b>P9B</b> Ball Entry Socket	2
	<b>P10</b> SLIDE SCORER	2
	<b>P11</b> PLUG	4
	<b>P12</b> TRIANGLE	4

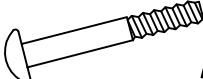
# PARTS IDENTIFIER

## REPLACEMENT PARTS

	DESCRIPTION	QTY
 <b>C1</b>	5 PLAYER ROD	2
 <b>C2</b>	3 PLAYER ROD	4
 <b>C3</b>	2 PLAYER ROD	2
 <b>C4</b>	RUBBER BUSHING	16
 <b>C5</b>	PLASTIC ROD WASHERS	16
 <b>C6</b>	BOLT(used to install men)	26
 <b>C7</b>	LOCKING NUT (used to install men)	26
 <b>C8</b>	HOME MEN	11
 <b>C9</b>	AWAY MEN	11
 <b>C10</b>	STOP RING	4

# ASSEMBLY INSTRUCTIONS

## SOCGER TABLE ASSEMBLY

1. ATTACH THE TWO END PANELS **P2** TO THE SIDE PANELS **P1** AS SHOWN IN **figure 1**. **REMEMBER: THE GROOVE MUST FACE INWARD TOWARD THE PLAY FIELD**. ATTACH THE END PANELS WITH BOLTS **H1** AND WASHERS **H3**.
2. ATTACH PLAY FIELD WITH SCREWS **H6** IN THE ENDS AS SHOWN IN **figure 1**.

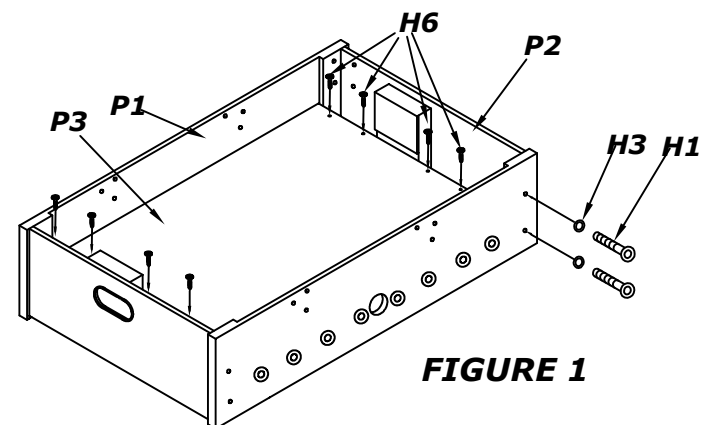

**FIGURE 1**

3. PLACE THE PLAYFIELD SUPPORT BRACES ON THE BOTTOM OF THE PLAYFIELD. ATTATCH THE BRACES USING BRACKETS **P6** AND SCREWS **H8**. AS SHOWN IN **figure 2**.

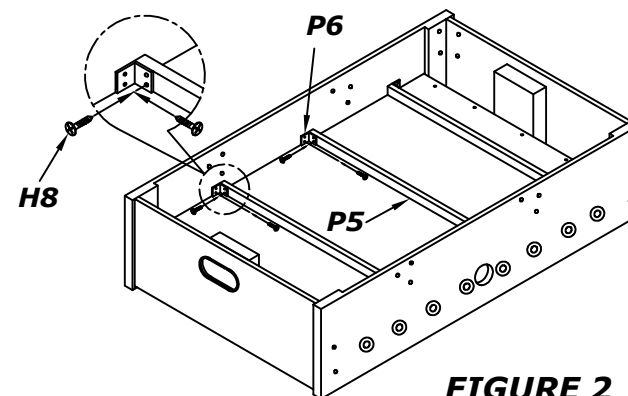

**FIGURE 2**